



EMC filters

1-line filters

Feedthrough filters

Rated current 16 to 500 A





Series/Type: **B85321**

Date: January 2006

1-line filters

Feedthrough components

Overview of available types

Type	Dia- meter mm	New	Rated current (A)	Rated voltage (VAC)	Rated capacitance (μ F)	Terminal type	Insertion loss in the frequency range (Hz)			Page
							10^5	10^6	10^7	
Feedthrough filters										
B85321A*+160	16	●	16	250	2×0.0025					5
B85321A*+160	20	●	25	250, 500	2×0.0025					6
B85321A*A250 B85321A*A750	30	●	25, 75	250	$2 \times 0.1 \dots$ 2×1.0					8
B85321A*A630, A101 ... A501	55	●	63 ... 500	250	$2 \times 0.5 \dots$ 2×4.7					10
										11

Legend

- Terminal type:
-  Tab connectors
 -  Axial leads
 -  Soldering tags
 -  Threaded studs

General

Feedthrough components from EPCOS are used for EMI suppression of all electrical installations and equipment. This new type series is also outstandingly well suited for telephone exchanges and base stations. Thanks to broadband EMI suppression up to the GHz range, it prevents external interference pulses being transmitted to the inside of the equipment via the supply network and vice-versa.

The essential features of this new type series are its modular design and the solder-free contacting technology developed by EPCOS with the aid of mesh contact.

Mesh contact technology permits uniform concentric contacting of the MKP capacitor winding and avoids the thermal stress associated with soldering. The result is an even higher insertion loss, a high insulation resistance and a particularly compact case.

The modular system used in this new technology for feedthrough capacitors and filters allows the cost-effective implementation of a wide range of standard types. Other capacitance values can also be supplied for special applications upon request.



Feedthrough components fitted into a shielding wall.

In feedthrough capacitors, the conductor carrying the operating current is connected concentrically to one electrode and is run centrally through the capacitor. The other electrode is contacted concentrically to the capacitor case.

Feedthrough capacitors are dimensioned so that they perform well from low frequencies to far above 300 MHz. The capacitor element with low inductance contacted securely on the face side is incorporated in a metal case provided with a screw thread.

The feedthrough filters are constructed in a π -circuit. They consist of two identical capacitive transverse elements and an inductive longitudinal element. The concentric layout of the components allows high insertion loss values to be attained in a frequency range to above 1 GHz.

Safety note

Feedthrough components with high capacitances require the implementation of safety measures in line with the applicable specifications! (See also Chapter "Mounting instructions".)

1-line filters

Feedthrough components

Mounting instructions

To fully utilize their RF properties, the feedthrough components must be mounted directly into shielding walls. The case must be contacted seamlessly (sealed against RF signals) to the shielding wall. This can be best done by screwing it into a threaded hole or bushing so that contact is made via the threads.

Alternatively, the feedthrough components may be screwed into feed-through holes on the shielding wall by means of attachment nuts. The contact between case and the shielding wall is then set up via the contact surface of the thread.

Caution

Contacts with rigid copper busbars are not permitted in view of mechanical stresses of the bushings due to impacts and vibrations.

For types with screw connections, the connecting cable must be secured between two nuts to exclude a torque on the feedthrough pins. The use of two flat wrenches is recommended.

Recommended tightening torques for feedthrough components (capacitors, filters)

Thread dimensions	Tightening torque (Nm)	Tolerance (Nm)	Terminal	Thread base attachment
M2	0.2	+0.05	×	
M3	0.6	+0.1	×	
M4	1.2	+0.1	×	
M5	2	+0.5	×	
M6	3	+0.5	×	
M8	5	+0.5	×	
M10	8	+2	×	
M12	12	+2	×	
M16	28	+2	×	
M18	35	+2	×	
M10 × 0.75	3	+0.5		×
M12 × 0.75	4	+0.5		×
M20 × 1	10	+1		×
M24 × 1.5	12	+1.5		×
M27 × 1.5	16	+2		×
M32 × 1.5	24	+2.5		×

Feedthrough filters
Rated voltage 250 V AC
Rated current 16 to 500 A
Rated capacitance 2×0.0025 to $2 \times 4.7 \mu\text{F}$
Construction

- Building-block system
- MKP technology (dry, self-healing)
Dielectric: polypropylene, metallized
- Metal case, polyurethane potting (UL 94 V-0)
- For central screw fixing

Features

- Compact dimensions
- Versions with rated voltage 440 V AC available on request
- High insertion loss
- Easy to install
- High contact reliability thanks to central screw fixing
- Comply with EN 133200
- UL approval 

Applications

Broadband interference suppression
for AC/DC supply lines, e.g. in

- shielded rooms
- telephone exchanges, base stations
- electrical machines and systems
- power supplies

Terminals

- Threaded studs
- Axial leads
- Soldering tag
- Tab connector

Marking

Manufacturer, ordering code, rated capacitance,
rated voltage, rated current, climatic category,
circuit diagram, date of manufacture (MM.YY), approvals

Circuit diagram

SSB1274-B



1-line filters	B85321A*+160
Feedthrough filters	∅ 16 mm, 16 A

Feedthrough filters ∅ 16 mm

Technical data and measuring conditions

Rated voltage V_R	250 V AC, 50/60 Hz 600 V DC
Rated current I_R	Referred to 40 °C ambient temperature Reduced current values at 400 Hz
Capacitance tolerance	±20%
Climatic category (IEC 60068-1)	40/085/56 (-40 °C/+85 °C/56 days damp heat test)
Screw cap fixing	M10 × 0.75
Approvals	UL 1283, 250 V

Characteristics and ordering codes

I_R A	C_R μF	V_R V AC	V_R V DC	V_{test} V DC	Terminal	Fig.	Ordering code	Approvals 
16	2 × 0.0025	250	600	2700	M2	1	B85321A2502X160	×
	2 × 0.0025	250	600	2700	Soldering tag	2	B85321A2502Y160	×
	2 × 0.0025	250	600	2700	Leads ∅ 2 mm	3	B85321A2502Z160	×
	2 × 0.0025	250	600	2700	Tab connector 6.3 mm	4	B85321A2502W160	×

× = approval granted

Insertion loss (dB); typical values at 50 Ω

C_R (μF)	10 kHz	100 kHz	1 MHz	10 MHz	100 MHz	1 GHz
2 × 0.0025	–	–	–	25	> 80	> 80

Dimensional drawings

Figure 1, B85321A2502X160

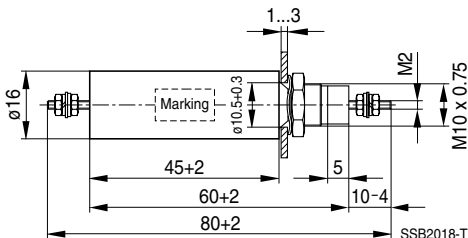

Thread	Tightening torque
M2	0.2 +0.05 Nm
M10 × 0.75	3 +0.5 Nm

1-line filters	B85321A*+160
Feedthrough filters	∅ 16 mm, 16 A

Figure 2, B85321A2502Y160

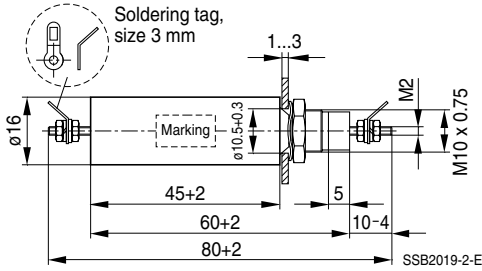

Thread	Tightening torque
M2	0.2 +0.05 Nm
M10 x 0.75	3 +0.5 Nm

Figure 3, B85321A2502Z160

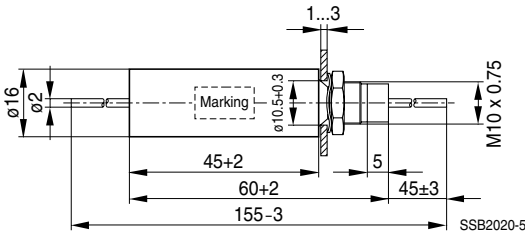

Tightening torque: 3 +0.5 Nm

Figure 4, B85321A2502W160

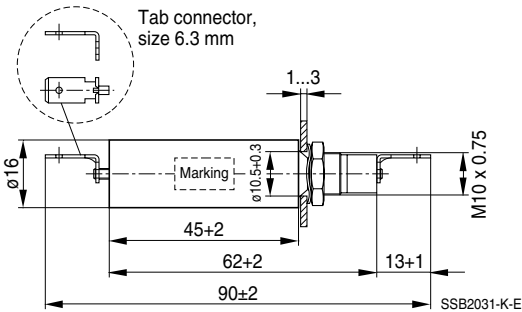

Tightening torque: 3 +0.5 Nm

1-line filters	B85321A*+160
Feedthrough filters	∅ 20 mm, 25 A

Feedthrough filters ∅ 20 mm

Technical data and measuring conditions

Rated voltage V_R	250 and 500 V AC, 50/60 Hz 600 and 700 V DC
Rated current I_R	Referred to 40 °C ambient temperature Reduced current values at 400 Hz
Capacitance tolerance	±20%
Climatic category (IEC 60068-1)	40/085/56 (−40 °C/+85 °C/56 days damp heat test)
Screw cap fixing	M12 × 0.75
Approvals	UL 1283, 250 V

Characteristics and ordering codes

I_R A	C_R μF	V_R V AC	V_R V DC	V_{test} V DC	Terminal	Figure	Ordering code	Approvals 
25	2 × 0.0025	250	600	2700	M4	1	B85321A2502A160	×
	2 × 0.0025	250	600	2700	Leads ∅ 2 mm	2	B85321A2502B160	×
	2 × 0.0025	500	700	3000			B85321A4502C160	×

× = approval granted

Insertion loss (dB); typical values at 50 Ω

C_R (μF)	10 kHz	100 kHz	1 MHz	10 MHz	100 MHz	1 GHz
2 × 0.0025	–	–	–	25	> 80	> 80

Dimensional drawings

Figure 1, B85321A2502A160

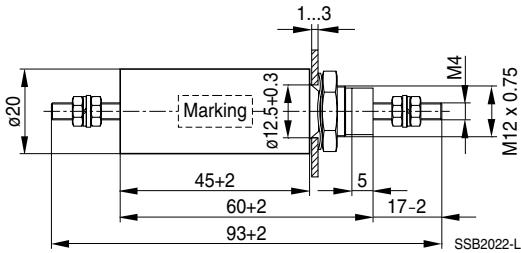

Thread	Tightening torque
M4	1.2 +0.1 Nm
M12 x 0.75	4.0 +0.5 Nm

Figure 2, B85321A2502B160, B85321A4502C160

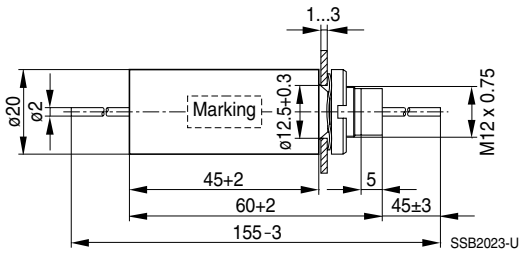

Tightening torque: 4 +0.5 Nm

1-line filters	B85321A*A250, A750
Feedthrough filters	∅ 30 mm, 25 A, 75 A

Feedthrough filters ∅ 30 mm

Technical data and measuring conditions

Rated voltage V_R	250 V AC, 50/60 Hz 500 and 600 V DC
Rated current I_R	Referred to 40 °C ambient temperature Reduced current values at 400 Hz
Capacitance tolerance	±20%
Climatic category (IEC 60068-1)	40/085/56 (-40 °C/+85 °C/56 days damp heat test)
Screw cap fixing	M20 × 1
Approvals	UL 1283, 250 V

Characteristics and ordering codes

I_R A	C_R μF	V_R V AC	V_R V DC	V_{test} V DC	Terminal	Ordering code	Approvals 
25	2 × 0.1	250	600	3000	M6	B85321A2204A250	×
	2 × 0.5	250	600	2000	M6	B85321A2105A250	×
	2 × 1.0	250	500	1700	M6	B85321A2205A250	×
75	2 × 0.1	250	600	3000	M6	B85321A2204A750	×
	2 × 0.5	250	600	2000	M6	B85321A2105A750	—
	2 × 1.0	250	500	1700	M6	B85321A2205A750	×

× = approval granted

Insertion loss (dB); typical values at 50 Ω

C_R (μF)	10 kHz	100 kHz	1 MHz	10 MHz	100 MHz	1 GHz
2 × 0.1	2	10	25	70	> 100	> 100
2 × 0.5	5	25	45	80	> 100	> 100
2 × 1.0	10	30	60	90	> 100	> 100

Dimensional drawing

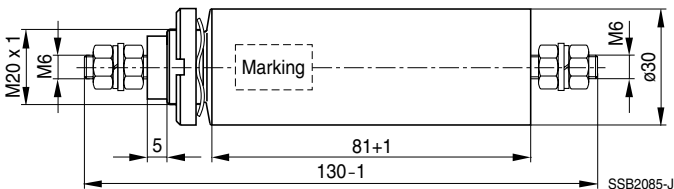

Thread	Tightening torque
M6	3 +0.5 Nm
M20 × 1	10 +1 Nm

1-line filters	B85321A*A630, A101 ... A501
Feedthrough filters	∅ 55 mm, 63 ... 500 A

Feedthrough filters ∅ 55 mm

Technical data and measuring conditions

Rated voltage V_R	250 V AC, 50/60 Hz 350 and 600 V DC
Rated current I_R	Referred to 40 °C ambient temperature Reduced current values at 400 Hz
Capacitance tolerance	±20%
Climatic category (IEC 60068-1)	40/085/56 (−40 °C/+85 °C/56 days damp heat test)
Screw cap fixing	Standard M32 × 1.5 Special fixing M27 × 1.5 for filters up to 300 A on request
Approvals	UL 1283, 250 V

Characteristics and ordering codes

I_R A	C_R μF	V_R V AC	V_R V DC	V_{test} V DC	Terminal	Dimensions (mm)			Ordering code	Approvals 
						l +1	l ₁ −1	l ₂ −3		
63	2 × 0.5	250	600	3000	M6	100	166	45	B85321A2105A630	×
	2 × 1.0	250	600	2500	M6	100	166	45	B85321A2205A630	×
	2 × 2.0	250	600	2500	M6	100	166	45	B85321A2405A630	×
	2 × 4.7	250	350	1700	M6	100	166	45	B85321A2945A630	×
100	2 × 0.5	250	600	3000	M8	100	180	52	B85321A2105A101	×
	2 × 1.0	250	600	2500	M8	100	180	52	B85321A2205A101	×
	2 × 2.0	250	600	2500	M8	100	180	52	B85321A2405A101	×
	2 × 4.7	250	350	1700	M8	100	180	52	B85321A2945A101	×
200	2 × 0.5	250	600	3000	M10	100	185	55	B85321A2105A201	×
	2 × 1.0	250	600	2500	M10	100	185	55	B85321A2205A201	×
	2 × 2.0	250	600	2500	M10	100	185	55	B85321A2405A201	×
	2 × 4.7	250	350	1700	M10	100	185	55	B85321A2945A201	×
300	2 × 0.5	250	600	3000	M12	100	195	60	B85321A2105A301	×
	2 × 1.0	250	600	2500	M12	100	195	60	B85321A2205A301	×
	2 × 2.0	250	600	2500	M12	100	195	60	B85321A2405A301	−
	2 × 4.7	250	350	1700	M12	100	195	60	B85321A2945A301	×
400	2 × 0.5	250	600	3000	M16	130	245	72	B85321A2105A401	−
	2 × 1.0	250	600	2500	M16	130	245	72	B85321A2205A401	−
	2 × 2.0	250	600	2500	M16	130	245	72	B85321A2405A401	−
	2 × 4.7	250	350	1650	M16	130	245	72	B85321A2945A401	−

× = approval granted

Characteristics and ordering codes

I _R A	C _R μF	V _R V AC	V _R V DC	V _{test} V DC	Terminal	Dimensions (mm)			Ordering code	Approvals 
						l +1	l ₁ -1	l ₂ -3		
500	2 × 0.5	250	600	3000	M18	130	250	75	B85321A2105A501	–
	2 × 1.0	250	600	2500	M18	130	250	75	B85321A2205A501	–
	2 × 2.0	250	600	2500	M18	130	250	75	B85321A2405A501	–
	2 × 4.7	250	350	1650	M18	130	250	75	B85321A2945A501	–

× = approval granted

Insertion loss (dB); typical values at 50 Ω

C _R (μF)	10 kHz	100 kHz	1 MHz	10 MHz	100 MHz	1 GHz
2 × 0.5	5	25	45	80	> 100	> 100
2 × 1.0	10	30	60	> 100	> 100	> 100
2 × 2.0	15	35	70	> 100	> 100	> 100
2 × 4.7	25	40	90	> 100	> 100	> 100

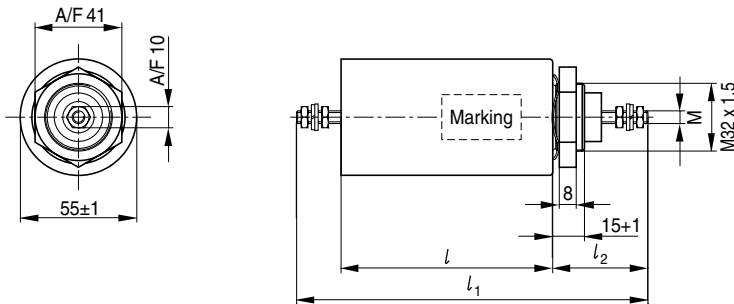
Dimensional drawing

SSB1273-3-E

Thread	Tightening torque
M6	3 +0.5 Nm
M8	5 +0.5 Nm
M10	8 +2 Nm
M12	12 +2 Nm
M16	28 +2 Nm
M18	35 +2 Nm

Thread	Tightening torque
M27 × 1.5	16 +2 Nm
M32 × 1.5	24 +2.5 Nm

Important information

Please read all safety and warning notes carefully before installing the EMC filter and putting it into operation (see ). The same applies to the warning signs on the filter. Please ensure that the signs are not removed nor their legibility impaired by external influences.

Death, serious bodily injury and substantial material damage to equipment may occur if the appropriate safety measures are not carried out or the warnings in the text are not observed.

Using according to the terms

The EMC filters may be used only for their intended application within the specified values in low-voltage networks in compliance with the instructions given in the data sheets and the data book. The conditions at the place of application must comply with all specifications for the filter used.

Warnings

- It shall be ensured that only qualified persons (electricity specialists) are engaged on work such as planning, assembly, installation, operation, repair and maintenance. They must be provided with the corresponding documentation.
- Danger of electric shock. EMC filters contain components that store an electric charge. Dangerous voltages can continue to exist at the filter terminals for longer than five minutes even after the power has been switched off.
- The protective earth connections shall be the first to be made when the EMC filter is installed and the last to be disconnected. Depending on the magnitude of the leakage currents, the particular specifications for making the protective-earth connection must be observed.
- Impermissible overloading of the EMC filter, such as impermissible voltages at higher frequencies that may cause resonances etc. can lead to destruction of the filter housing.
- EMC filters must be protected in the application against impermissible exceeding of the rated currents by suitable overcurrent protective.

The following applies to all products named in this publication:

1. Some parts of this publication contain **statements about the suitability of our products for certain areas of application**. These statements are based on our knowledge of typical requirements that are often placed on our products in the areas of application concerned. We nevertheless expressly point out **that such statements cannot be regarded as binding statements about the suitability of our products for a particular customer application**. As a rule, EPCOS is either unfamiliar with individual customer applications or less familiar with them than the customers themselves. For these reasons, it is always ultimately incumbent on the customer to check and decide whether an EPCOS product with the properties described in the product specification is suitable for use in a particular customer application.
2. We also point out that **in individual cases, a malfunction of passive electronic components or failure before the end of their usual service life cannot be completely ruled out in the current state of the art, even if they are operated as specified**. In customer applications requiring a very high level of operational safety and especially in customer applications in which the malfunction or failure of a passive electronic component could endanger human life or health (e.g. in accident prevention or life-saving systems), it must therefore be ensured by means of suitable design of the customer application or other action taken by the customer (e.g. installation of protective circuitry or redundancy) that no injury or damage is sustained by third parties in the event of malfunction or failure of a passive electronic component.
3. **The warnings, cautions and product-specific notes must be observed.**
4. In order to satisfy certain technical requirements, **some of the products described in this publication may contain substances subject to restrictions in certain jurisdictions (e.g. because they are classed as “hazardous”)**. Useful information on this will be found in our Material Data Sheets on the Internet (www.epcos.com/material). Should you have any more detailed questions, please contact our sales offices.
5. We constantly strive to improve our products. Consequently, **the products described in this publication may change from time to time**. The same is true of the corresponding product specifications. Please check therefore to what extent product descriptions and specifications contained in this publication are still applicable before or when you place an order.
We also **reserve the right to discontinue production and delivery of products**. Consequently, we cannot guarantee that all products named in this publication will always be available.
6. Unless otherwise agreed in individual contracts, **all orders are subject to the current version of the “General Terms of Delivery for Products and Services in the Electrical Industry” published by the German Electrical and Electronics Industry Association (ZVEI)**.
7. The trade names EPCOS, EPCOS-Jones, Baoke, CeraDiode, CSSP, MLSC, PhaseCap, PhaseMod, SIFI, SIKOREL, SilverCap, SIMID, SIOV, SIP5D, SIP5K, UltraCap, WindCap are **trademarks registered or pending** in Europe and in other countries. Further information will be found on the Internet at www.epcos.com/trademarks.